

AIR-INSULATED SWITCHGEAR UP TO 36 kV
FOR PRIMARY AND SECONDARY DISTRIBUTION SYSTEMS

SG40_MILE | 36 kV, 3150 A, 31.5 kA



CONTINUOUS INNOVATION

Introduction

TE Energy SG_40 is an extension of the MILE product line into a new voltage class of up to 36 kV. The new product inherits the field-proven design and commitment to develop SF6-free switchgear solutions. Supporting the growing movement towards banning sulfur hexafluoride (SF6) insulated switchgear due to its significant environmental impact, the MILE family switchgear is based on air insulation technology and digital capabilities, offering a great solution for modern power distribution systems.



Recognizing the urgency to mitigate climate change, various norms, standards, and regulations have been established to phase out SF6-insulated switchgear. The regulatory frameworks such as the European Union's F-Gas Regulation (EU) No 517/2014 emphasize the adoption of air-insulated switchgear with vacuum circuit breakers and aim to reduce emissions of fluorinated greenhouse gases, including SF6, through strict containment measures and gradual phase-outs.

In support of green issues throughout the entire product life, MILE utilizes fully recyclable materials ensuring safe and efficient product recycling at the end of its life. This guarantees a completely sustainable solution utilizing MILE applications. To highlight our commitment to design and manufacture environmentally friendly products, the Birch style of MILE has been implemented.

Adhering to the highest international quality standards, our products are manufactured within the European Union (Tallinn, Estonia) in compliance with ISO 9001 and ISO 14001 certifications.



STATE-OF-THE-ART MANUFACTURING

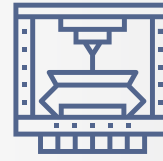
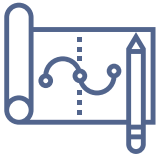

- Application of the latest technologies in sheet metal and copper busbar processing such as laser cutting, CNC machining, powder coating, electroplating, etc. allows MILE to meet the highest standards in quality product production.



- In-house testing facilities are available to conduct primary and secondary current injection tests as well as high voltage and partial discharge tests which constitute the core of the comprehensive routine testing program on MILE.



FIELD-PROVEN DESIGN WITH FLOOR TRUCK VCB



The SG40 inherits the field-proven design of the MILE family. It has a typified design so that the arrangement of equipment and instruments in the panel represents the mainstream concept of switchgear specified by most customers worldwide. Additionally, the floor truck design allows easy removal and maintenance of the vacuum circuit breaker.

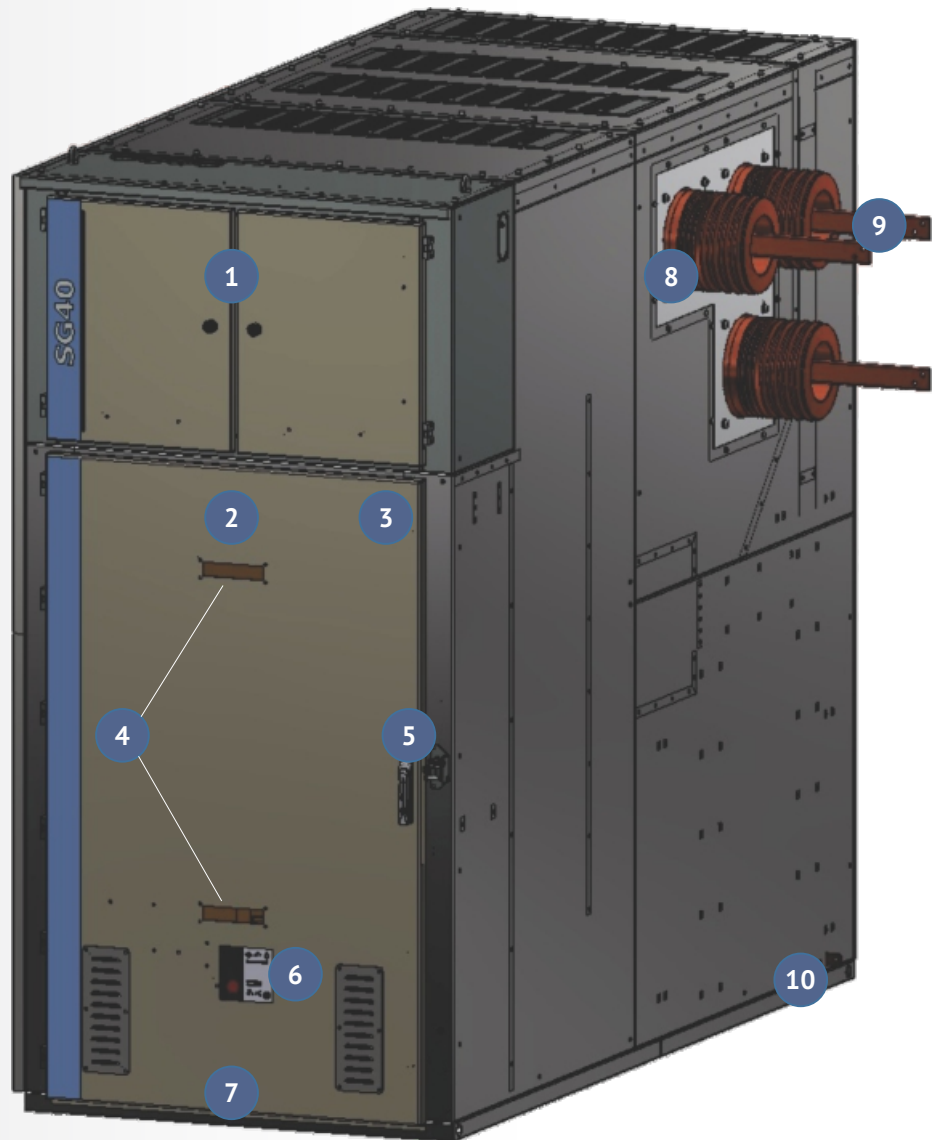

- 1 LV compartment
- 2 VCB compartment
- 3 Nameplate
- 4 Inspection windows
- 5 Earthing switch control
- 6 VCB control
- 7 Ventilation grills
- 8 Through insulators
- 9 Main busbars
- 10 Earthing busbar



MILE is created for straightforward manufacturing. No turning, grinding or cleansing is necessary. No jigs or welding processes are required for assembly. The enclosure is made of corrosive resistant hot-dip galvanized metal sheets. Its design allows fast assembly with rivets and screws only.

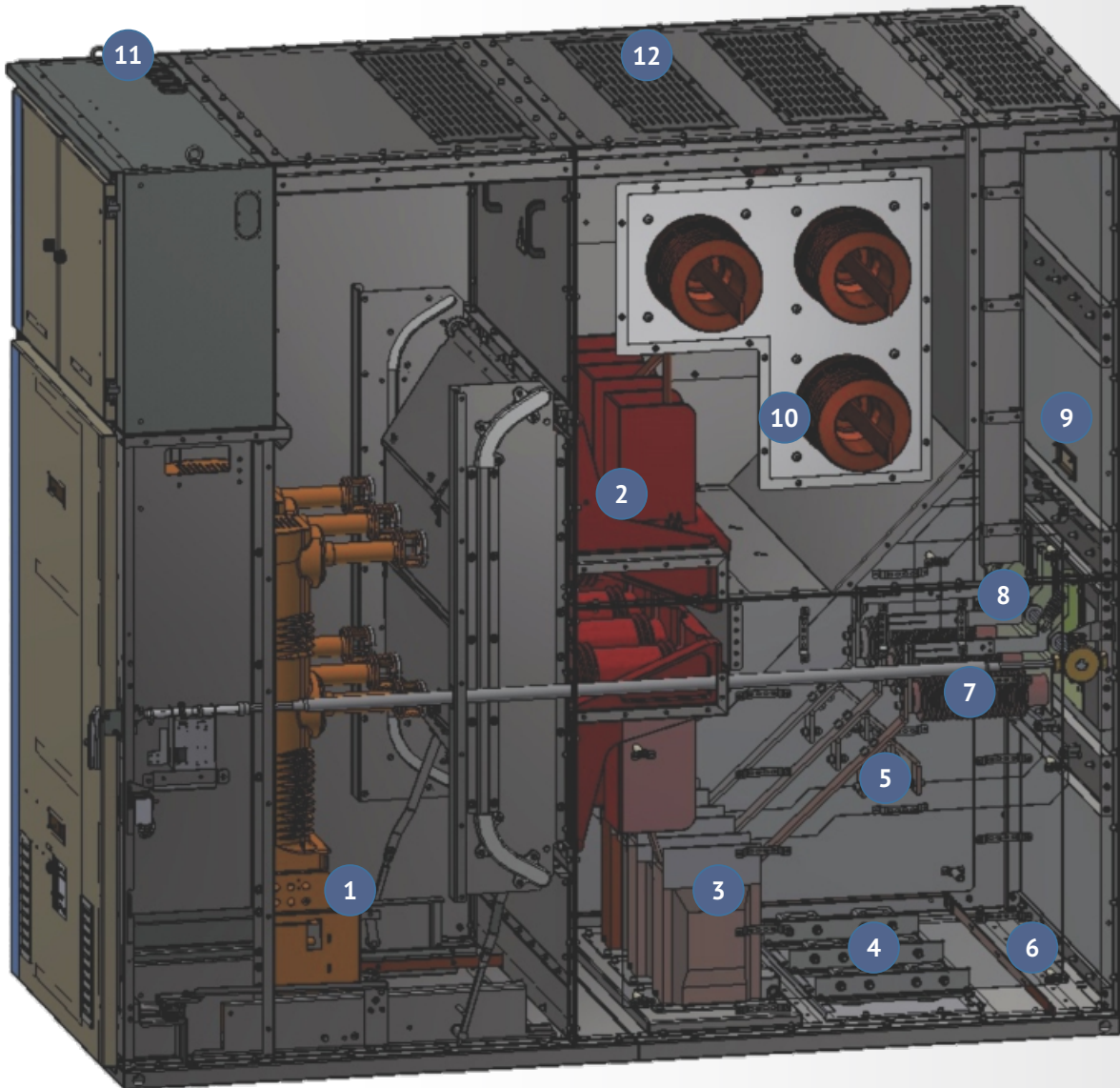

- | | | | |
|---|--------------------------------|----|-------------------------------------|
| 1 | Withdrawable VCB | 7 | Capacitive support insulators |
| 2 | Contact box | 8 | Earthing switch |
| 3 | Current transformers | 9 | Rear inspection window |
| 4 | Bottom inlets for power cables | 10 | Through insulators and main busbars |
| 5 | Cable connection busbars | 11 | Top inlets for secondary cables |
| 6 | Main earthing bar | 12 | Pressure relief flaps |

BENEFITS

The SG40 is the result of long experience collected over the years and dedicated engineering innovation. Combining the expert knowledge, cutting edge technologies with high quality materials, the new switchgear offers unparalleled reliability and safety for the operator and the environment.



Designed and fully type tested in accordance with the latest revision of the IEC 62271-200 standard for high-voltage switchgear, ensuring safety, reliability and best performance in various applications.



Passed an internal arc fault test for 31.5kA/1s (IAC AFLR classification) to meet the most stringent safety requirements.



The floor truck design ensures exceptional safety for the operator and ease of maintenance.



The reinforced enclosure, made of 2mm corrosive resistant hot-dip galvanized metal sheets and robust components designed to withstand thousands of operations.



SF6-free air insulation reduces the environmental impact and avoids the end-of-life recycling process.



LS SUSOL™ VACUUM CIRCUIT BREAKER

LS Electric is one of the global leaders with more than 30 years of experience in the manufacturing of switchgear solutions for various industrial applications. The company is a member of the LS Group, with headquarters in South Korea.

LS Electric Susol VH-36 series circuit breakers with embedded vacuum interrupters are premium products featuring sustainable technologies, compact size, high reliability and a variety of accessories for safe, stable and reliable power supply.



High-performing core materials are designed to operate under harsh industrial environments and provide excellent protection against mechanical shocks, dust and moisture for the entire lifetime.

- Switching capability up to 40 kA at 40,5 kV
- Class E2, M2, C2



Global leader with more than 30 years of experience. International certification and access to global markets:

- Type test certification acc. to IEC 62271-100
- North America UL certification
- Marine certification (KR, LR, BV, GL, DNV, ABS, NK)



Environmentally friendly vacuum technology circuit breakers with commitment to supporting and developing sustainable switchgear products.



"Futuring Smart Energy"



PANEL CONFIGURATIONS

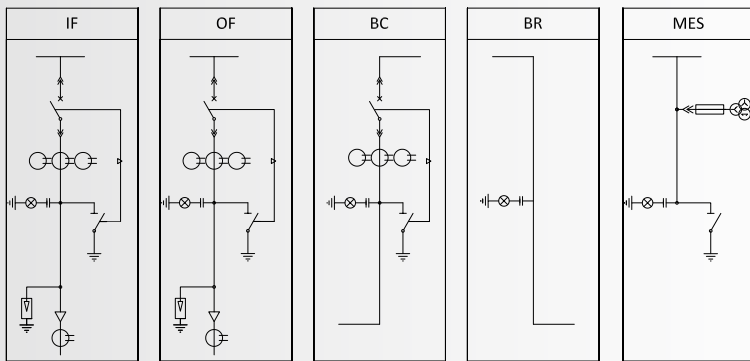

DIMENSIONS AND WEIGHTS

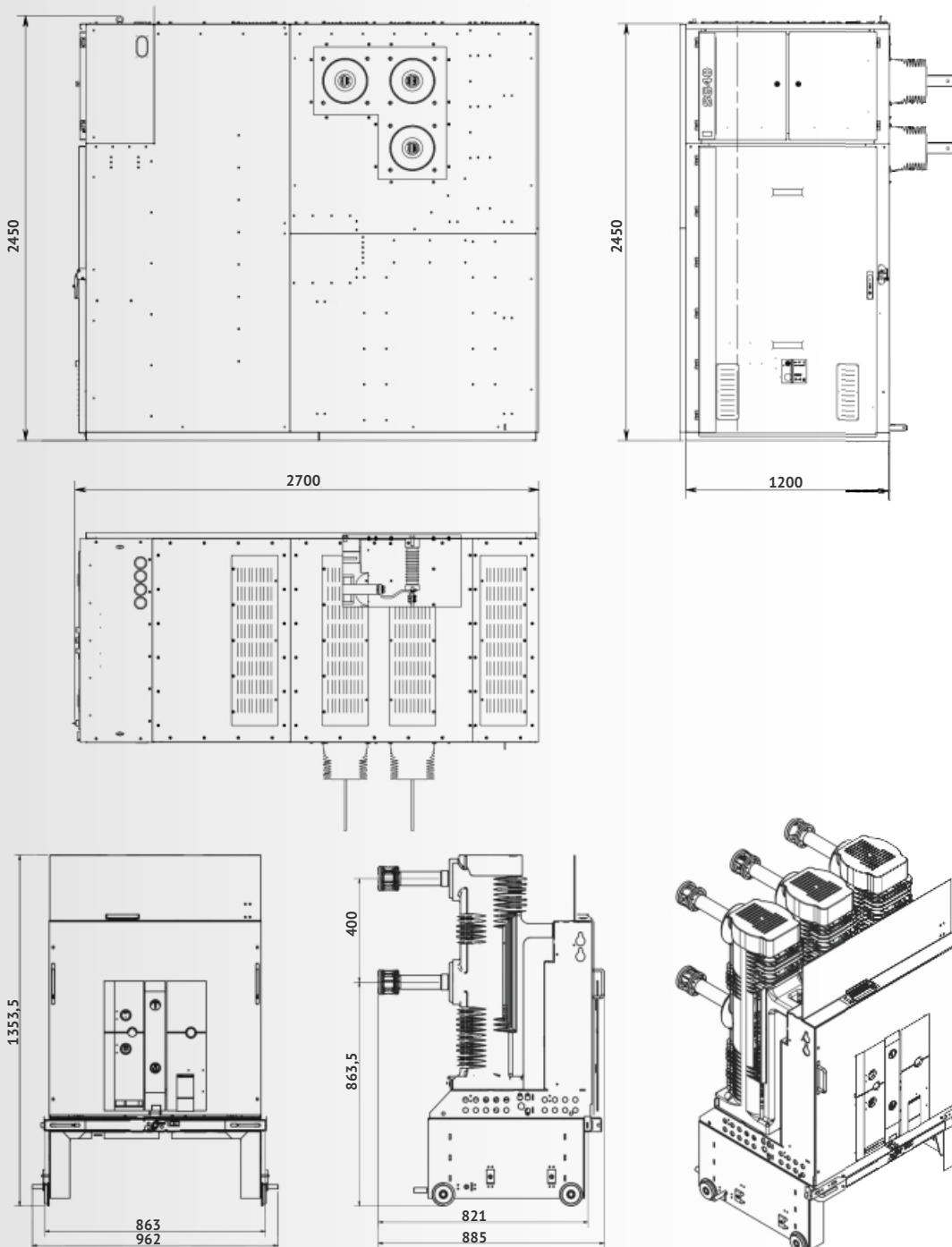

TECHNICAL SPECIFICATIONS

The rated characteristics of the switchgear are guaranteed under the following ambient conditions:

Parameter	Parameter value
Minimum ambient temperature	- 5 °C*
Maximum ambient temperature	+ 55 °C**
Maximum altitude above sea level	1000 m ***
Relative humidity	95%
Ambient atmosphere	Normal, non-corrosive and uncontaminated

* Value is limited by instrument transformers and electronic protection devices.

** IEC 62271-1 limits the upper level of ambient temperature at +40°C.

*** For installations in altitudes above 1000 m, the external insulation is calculated as multiplication of rated insulation with Ka in accordance with IEC 62271-1.

The SG_MILE series switchgear are suitable for operation in the climate of Wda type in accordance with IEC 60721-2-1 standard.

The operational environment must be free of dust, fumes, corrosive or flammable gases or salts.

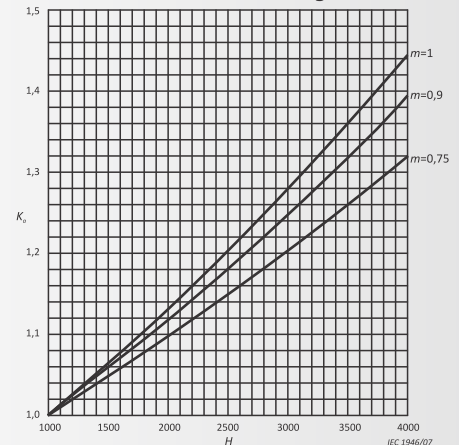

Main technical data:

Insulation type	Air
Maintenance version	Front/rear access
Rated voltage, kV	36/40.5*
Rated power frequency withstand voltage, 1 min, kV	70/95*
Rated lightning impulse withstand voltage, kV	170/190*
Rated frequency, Hz	50/60
Rated current, A	630;1250;1600;2000;2500;3150
Rated breaking current, kA	25; 31,5
Rated short-time withstand current (3 s), kA	25; 31,5
Rated peak withstand current, kA	64; 82
Rated supply voltage for auxiliary circuits, V	24/48/110/220DC; 100-230AC
IAC classification (IEC62271-200)	AFLR 31,5kA/1s
Loss of service continuity and partition class	LSC2B-PM
Dimensions (WxDxH), mm	2450 x 1200 x 2700
Class of protection	IP4X** / IK10

* Extended BIL version on request

** IP41 on request

Applicable standards:

High-voltage switchgear and control gear – Part 1: Common specifications	IEC 62271-1
High-voltage switchgear and control gear – Part 100: High-voltage alternating current circuit-breakers	IEC 62271-100
High-voltage switchgear and control gear – Part 200: High-voltage alternating current disconnectors and earthing switches	IEC 62271-102
High-voltage switchgear and controlgear – Part 200: AC metal-enclosed switchgear and controlgear for rated voltages above 1 kV and up to and including 52 kV	IEC 62271-200
Degrees of protection provided by enclosures (IP Code)	IEC 60529
Instrument transformers - Part 1: General requirements	IEC 61869-1
Instrument transformers - Part 2: Additional requirements for current transformers	IEC 61869-2
Instrument transformers - Part 3: Additional requirements for inductive voltage transformers	IEC 61869-3
Measuring relays and protection equipment	IEC 60255
Surge arresters - Part 4: Metal-oxide surge arresters without gaps for a.c. systems	IEC 60099-4
Voltage detecting systems (VDS)	IEC 61243-5
VPIS systems for rated voltages between 1kV and 52kV	IEC 62271-206
Protection against electric shock - Common aspects for installation and equipment	IEC 61140
EU LV directive; EMC directive	2014/35/EU; 2014/30/EU

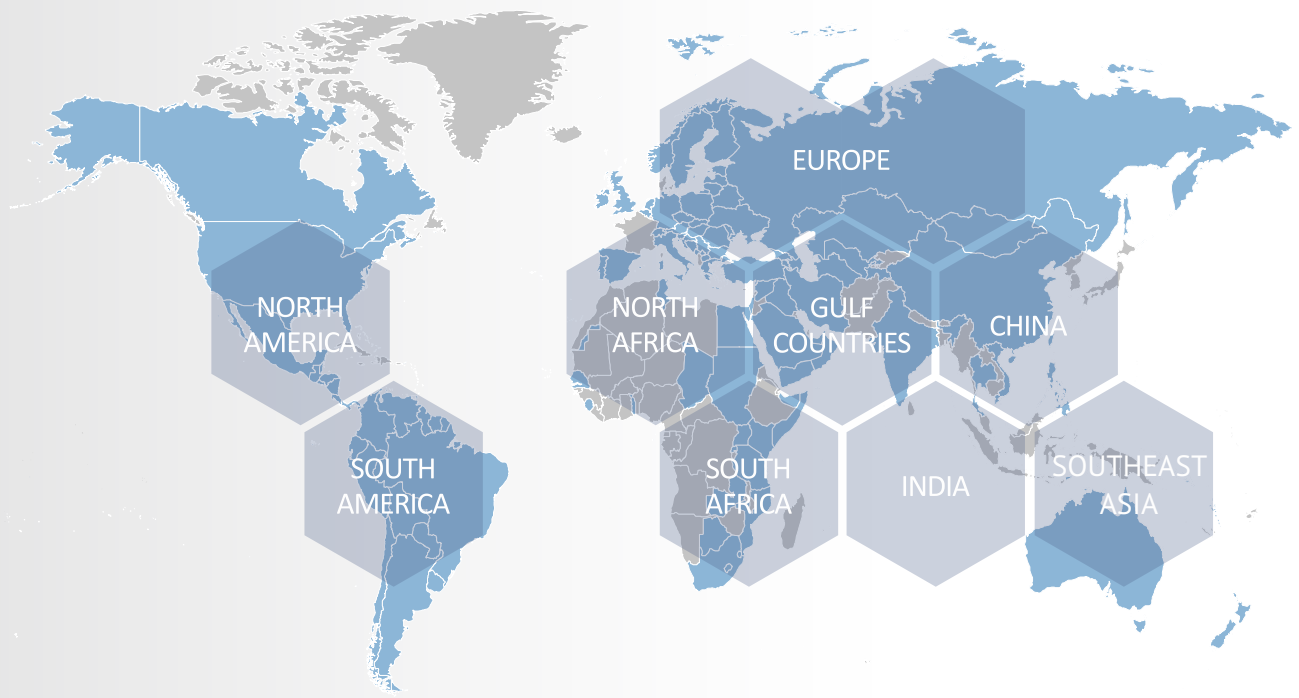

TE²Energy

On time with Confidence

14, Visase str.,
Tallinn 11415 Estonia

Tel.: +372 606 47 57

E-mail: info@mile.energy
Web: www.mile.energy

rev. 1. 26.3.2024

This document is copyright and is intended for users and distributors of TE Energy products. It contains information that is the intellectual property of TE Energy and this document or any part thereof, should not be copied or reproduced in any form without the prior permission of TE Energy. TE Energy applies a policy of ongoing development and reserves the right to change products without notice. TE Energy does not accept any responsibility for loss or damage incurred as a result of acting or refraining from action based on information in this document.